

# VALLEES



**Butterfly Valves**

## BUTTERFLY VALVES

### “B” SERIES BUTTERFLY VALVES

---

#### BUTTERFLY VALVES....

Butterfly Valves are available in Manual, Air Actuated, or Air Actuated with two Micro switches and a Solenoid Valve. Clamp or Weld ends are standard. Other connections are available upon request.

Available seat materials include Silicone, Viton®, and EPDM. Sizes range from 1” through 4”. All product contact surfaces are available in either T304 or T316 stainless steel.



#### BUTTERFLY VALVES SPECIFICATIONS....

**Size Range:** 1” through 4” sizes available

**Materials:** T304  
T316

**Info:** All stainless handle with eight positions is standard. Each position is set in 45° increments.

Silicone seats are standard - other seats available are EPDM and Viton®.

#### ORDERING SPECIFICATIONS....

**Specify:**

- Quantity
- Product description or Part No.
- Size
- Material Type

#### VNE CORPORATION

P.O. Box 1698 • 1149 Barberry Drive • Janesville, WI 53547

TEL: 608-756-4930 • FAX: 608-756-3643 • 1-800-356-1111 • Web site: [vnestainless.com](http://vnestainless.com)

## EGCCB - CLAMP

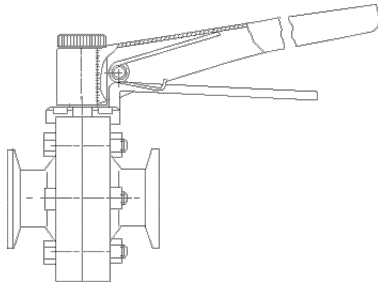

Size	Silicone / EPDM		Viton	
	304	316	304	316
1	\$164.45	\$286.67	\$186.67	\$308.89
1 1/2	\$166.67	\$291.12	\$186.67	\$324.45
2	\$191.12	\$331.12	\$213.34	\$373.34
2 1/2	\$224.45	\$371.12	\$253.34	\$433.34
3	\$291.12	\$451.12	\$324.45	\$517.78
4	\$397.78	\$555.56	\$442.23	\$606.67

## EGSSB - WELD

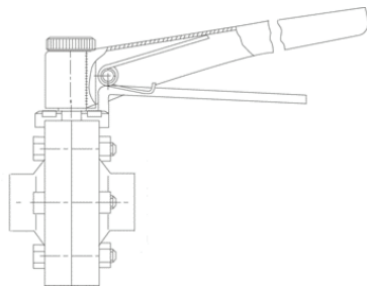

Size	Silicone / EPDM		Viton	
	304	316	304	316
1	\$164.45	\$286.67	\$186.67	\$308.89
1 1/2	\$166.67	\$291.12	\$186.67	\$324.45
2	\$191.12	\$331.12	\$213.34	\$373.34
2 1/2	\$224.45	\$371.12	\$253.34	\$433.34
3	\$291.12	\$451.12	\$324.45	\$517.78
4	\$397.78	\$555.56	\$442.23	\$606.67

## APPCCB - NE - CLAMP

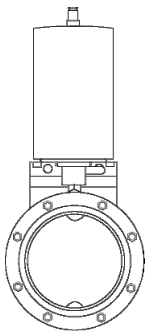

Size	Silicone / EPDM		Viton	
	304	316	304	316
1	\$600.00	\$733.34	\$633.34	\$777.78
1 1/2	\$600.00	\$733.34	\$633.34	\$777.78
2	\$622.23	\$777.78	\$666.67	\$822.23
2 1/2	\$677.78	\$822.23	\$706.67	\$877.78
3	\$744.45	\$888.89	\$777.78	\$966.67
4	\$855.56	\$1,000.00	\$877.78	\$1022.23

## APPSSB - NE - WELD

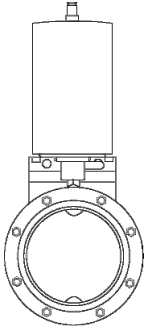

Size	Silicone / EPDM		Viton	
	304	316	304	316
1	\$688.89	\$822.23	\$722.23	\$866.67
1 1/2	\$688.89	\$822.23	\$722.23	\$866.67
2	\$711.12	\$866.67	\$755.56	\$911.12
2 1/2	\$766.67	\$911.12	\$795.56	\$966.67
3	\$833.34	\$977.78	\$866.67	\$1,055.56
4	\$944.45	\$1,088.89	\$966.67	\$1,111.12

## REPLACEMENT PARTS



Silicone



EPDM



Viton



Disc



Bushing

Part Number	List Price
BVP - B - 96 - 7 - 1.0 - H	\$33.34
BVP - B - 96 - 7 - 1.5 - H	\$36.67
BVP - B - 96 - 7 - 2.0 - H	\$41.67
BVP - B - 96 - 7 - 2.5 - H	\$50.00
BVP - B - 96 - 7 - 3.0 - H	\$53.34
BVP - B - 96 - 7 - 4.0 - H	\$63.34
BVP - B - 96 - 8 - 1.0 - H	\$33.34
BVP - B - 96 - 8 - 1.5 - H	\$36.67
BVP - B - 96 - 8 - 2.0 - H	\$41.67
BVP - B - 96 - 8 - 2.5 - H	\$50.00
BVP - B - 96 - 8 - 3.0 - H	\$53.34
BVP - B - 96 - 8 - 4.0 - H	\$63.34
BVP - B - 96 - 9 - 1.0 - H	\$142.23
BVP - B - 96 - 9 - 1.5 - H	\$142.23
BVP - B - 96 - 9 - 2.0 - H	\$153.34
BVP - B - 96 - 9 - 2.5 - H	\$186.67
BVP - B - 96 - 9 - 3.0 - H	\$197.78
BVP - B - 96 - 9 - 4.0 - H	\$277.78
BVP - B - 96 - 3 - 1.0 - H	\$86.00
BVP - B - 96 - 3 - 1.5 - H	\$93.45
BVP - B - 96 - 3 - 2.0 - H	\$104.67
BVP - B - 96 - 3 - 2.5 - H	\$125.56
BVP - B - 96 - 3 - 3.0 - H	\$165.45
BVP - B - 96 - 3 - 4.0 - H	\$393.34
BVP - B - 96 - 4 - 1 - 1.5 - H	\$4.78
BVP - B - 96 - 4 - 2 - 2.5 - H	\$4.78
BVP - B - 96 - 4 - 3 - 4 - H	\$4.75

## REPLACEMENT PARTS

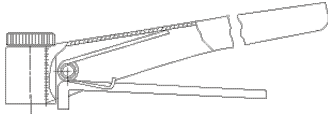

Part Number	List Price
BVP - B - 96 - 10	\$69.78
ACT - AS - NE - B ACT - AP - NE - B	\$644.45 \$555.56

# VALVES



**Check Valves**

## CHECK VALVES

### BALL, SPRING AND AIR BLOW CHECK VALVES

#### CHECK VALVES....

Check Valves are widely used for both sanitary and industrial applications to prevent backflow of product.

Ball Check Valves are designed to allow full product flow during processing. Once the product flow stops the ball rolls back to the seat at inlet preventing back flow. Ball Check Valves are commonly used with liquid products. Sizes range 1 1/2" - 3".

Spring Check Valves are designed to assist closure pressure to create a positive shutoff. They are commonly used with liquid products. Sizes range 1" - 4".

Both valves are offered with clamp or weld ends. Other connections are available upon request. Valves are made of T316L stainless steel.

Air Blow Check Valves are designed to evacuate lines of product or CIP solutions. Air Blow Check Valves are made of T316L Stainless Steel.



#### ORDERING SPECIFICATIONS....

- Specify:**
- Quantity
  - Product description or Part No.
  - Size
  - Material Type



## BALL CHECK VALVE

### EG45BY - CLAMP

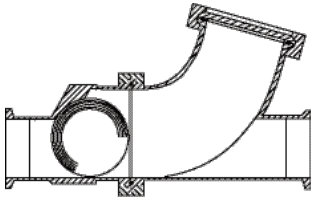

Size	Buna	Viton
1 1/2	\$833.34	\$933.34
2	\$911.12	\$973.34
2 1/2	\$1,333.34	\$1,422.23
3	\$1,633.34	\$1,966.67

### E45BYWW - WELD

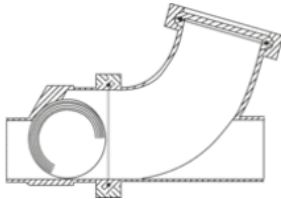

Size	Buna	Viton
1 1/2	\$833.34	\$933.34
2	\$911.12	\$973.34
2 1/2	\$1,333.34	\$1,422.23
3	\$1,633.34	\$1,966.67

## REPLACEMENT PARTS

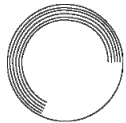

Buna = 3B



Viton = 3V



Buna = 8B



Viton = 8V

Part Number	List Price
BCV3B - 1.5	\$109.45
BCV3B - 2.0	\$146.67
BCV3B - 2.5	\$546.67
BCV3B - 3.0*	\$628.89
BCV3V - 1.5	\$257.78
BCV3V - 2.0	\$311.12
BCV3V - 2.5	\$1,111.12
BCV3V - 3.0*	\$1,222.23
BCV6/8B - 1.5	\$0.67
BCV6/8B - 2.0	\$0.96
BCV6/8B - 2.5	\$1.45
BCV6/8B - 3.0*	\$8.34
BCV6/8V - 1.5	\$7.89
BCV6/8V - 2.0	\$10.23
BCV6/8V - 2.5	\$12.78
BCV6/8V - 3.0*	\$58.67

\* Redesigned February 2003. Valves purchased after 2003 use 2.5" components

### SPRING CHECK VALVE

#### 45C - CLAMP

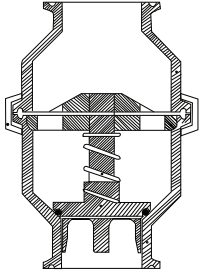

Size	EPDM	Viton
1/2	\$264.45	\$264.45
3/4	\$293.34	\$293.34
1	\$333.34	\$333.34
1 1/2	\$344.45	\$344.45
2	\$382.23	\$382.23
2 1/2	\$595.56	\$595.56
3	\$708.89	\$708.89
4	\$1,020.00	\$1,020.00

#### 45W - WELD

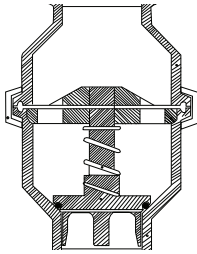

Size	EPDM	Viton
1/2	\$264.45	\$264.45
3/4	\$293.34	\$293.34
1	\$333.34	\$333.34
1 1/2	\$344.45	\$344.45
2	\$382.23	\$382.23
2 1/2	\$595.56	\$595.56
3	\$708.89	\$708.89
4	\$1,020.00	\$1,020.00

#### REPLACEMENT PARTS

	Part Number	List Price
Spring - Heavy	45-SCV3-.5-.2.0	\$22.23
	45-SCV3-2.5 - 4.0	\$33.34
Spring - Light - Standard	45-SCV3L-.5-.2.0	\$20.00
	45-SCV3L-2.5 - 4.0	\$31.12
O-Ring - Viton	45-SCV4-.5-.75	\$26.67
	45-SCV4 - 1.0-1.5	\$26.67
	45-SCV4-2.0	\$26.67
	45-SCV4-2.5	\$40.00
	45-SCV4-3.0	\$40.00
	45-SCV4-4.0	\$40.00

### AIR BLOW CHECK VALVE

#### EG62 - CLAMP

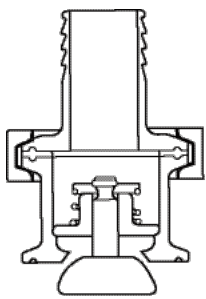

Size	EPDM			Viton		
	A	B	C	A	B	C
1 1/2	\$311.12	\$311.12	\$311.12	\$435.56	\$435.56	\$435.56
2	\$335.56	\$335.56	\$335.56	\$455.56	\$455.56	\$455.56
2 1/2	\$366.67	\$366.67	\$366.67	\$491.12	\$491.12	\$491.12
3	\$402.23	\$402.23	\$402.23	\$526.67	\$526.67	\$526.67
4	\$473.34	\$473.34	\$473.34	\$588.89	\$588.89	\$588.89

REPLACEMENT PARTS - Filter Disc - ABV9 - sold in 50 piece package only - \$1.23 each filter

### BALL CHECK WITH AIR BLOW CHECK VALVE

#### EG45 - CLAMP

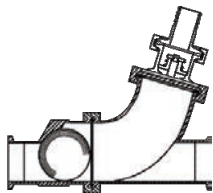

Size	BUNA			Viton		
	ABA	ABB	ABC	ABA	ABB	ABC
1 1/2	\$1,200.00	\$1,200.00	\$1,200.00	\$1,424.45	\$1,424.45	\$1,424.45
2	\$1,313.34	\$1,313.34	\$1,313.34	\$1,500.00	\$1,500.00	\$1,500.00
2 1/2	\$1,806.67	\$1,806.67	\$1,806.67	\$2,011.12	\$2,011.12	\$2,011.12
3	\$2,153.34	\$2,153.34	\$2,153.34	\$2,464.45	\$2,464.45	\$2,464.45

#### E45WW - WELD

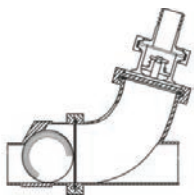

Size	BUNA			Viton		
	ABA	ABB	ABC	ABA	ABB	ABC
1 1/2	\$1,200.00	\$1,200.00	\$1,200.00	\$1,424.45	\$1,424.45	\$1,424.45
2	\$1,313.34	\$1,313.34	\$1,313.34	\$1,500.00	\$1,500.00	\$1,500.00
2 1/2	\$1,806.67	\$1,806.67	\$1,806.67	\$2,011.12	\$2,011.12	\$2,011.12
3	\$2,153.34	\$2,153.34	\$2,153.34	\$2,464.45	\$2,464.45	\$2,464.45

# VALLEES



**Ball Valves**

## BALL VALVES....

Ball Valves are used in a wide variety of high pressure applications. Two factors make them popular. First, a full unrestricted flow that allows no product restrictions through the valve. Second, the three piece design and the removal of a minimal number of bolts allows service to be performed without removing the complete valve from the line.

VNE offers two way ball valves made of T316 (CF8M) stainless steel. PTFE seats are easily removed. Clamp and Weld ends are standard. Other connections are available upon request. 1/2" through 4" sizes are available. Ball Valves meet 3A requirements.



## BALL VALVE SPECIFICATIONS....

<b>Size:</b>	1/2", 3/4", 1", 1 1/2", 2", 2 1/2", 3", 4"
<b>Material:</b>	Passivated 316 Stainless Steel (ASTM A351, CF8M)
<b>Connections:</b>	Clamp, Buttweld, & Orbital weld - other connections available upon request
<b>Working Pressure:</b>	1/2" - 1"            1,000 psi 1 1/2" - 2"        1,000 psi 2 1/2" - 4"        600 psi

## ORDERING SPECIFICATIONS....

- Specify:**
- Quantity
  - Product description or Part No.
  - Size
  - Material Type

## IMPORTANT FEATURES...

- 3 - Piece design - allows valve ends to remain attached while servicing valve body
- Meets 3A requirements
- 100% Tested
- Valves marked with heat numbers for full identification and traceability
- English hardware
- Maintenance and servicing is made easy with removal of a minimal number of bolts
- Reinforced Teflon® Seats
- PTFE Cavity Filler, fully encapsulated
- Locking device handle
- Air Actuator mounting kits which include ISO-5211 pads are available
- Repair kits are available

Teflon is a trademark

## VNE CORPORATION

P.O. Box 1698 • 1149 Barberry Drive • Janesville, WI 53547

TEL: 608-756-4930 • FAX: 608-756-3643 • 1-800-356-1111 • Web site: [vnestainless.com](http://vnestainless.com)

## CLAMP AND WELD VALVES

### EG90CC - CLAMP

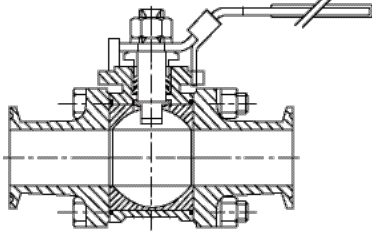

Size	316
1/2	\$82.23
3/4	\$100.00
1	\$137.78
1 1/2	\$233.34
2	\$335.56
2 1/2	\$733.34
3	\$966.67
4	\$1,655.56

### E90WW - WELD

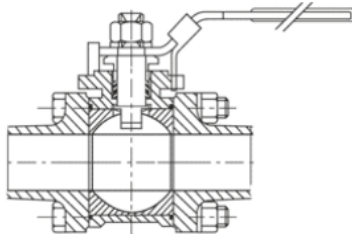

Size	316
1/2	\$82.23
3/4	\$100.00
1	\$137.78
1 1/2	\$233.34
2	\$335.56
2 1/2	\$733.34
3	\$966.67
4	\$1,655.56

## REPLACEMENT PARTS

	Part Number	List Price
Handle	BALL - 15 - .5	\$44.45
	BALL - 15 - .75	\$44.45
	BALL - 15 - 1.0	\$44.45
	BALL - 15 - 1.5	\$55.56
	BALL - 15 - 2.0	\$55.56
	BALL - 15 - 2.5	\$55.56
	BALL - 15 - 3.0	\$66.67
	BALL - 15 - 4.0	\$66.67
Repair Kit	BALLRepairKit - .5	\$17.78
	BALLRepairKit - .75	\$31.12
	BALLRepairKit - 1.0	\$44.45
	BALLRepairKit - 1.5	\$108.89
	BALLRepairKit - 2.0	\$137.78
	BALLRepairKit - 2.5	\$246.67
	BALLRepairKit - 3.0	\$400.00
	BALLRepairKit - 4.0	\$711.12

## BALL VALVES...

Ball Valves are used in a wide variety of high pressure applications. A full unrestricted flow allows no product restrictions through the valve. Thus, allowing easy diversion.

VNE offers three way ball valves made of T316 (CF8M) stainless steel. With PTFE seats that are easily removed. Clamp and Weld ends are standard. Other connections are available upon request. 1/2" through 4" sizes are available. Ball Valves meet 3A requirements.



## BALL VALVE SPECIFICATIONS...

<b>Size:</b>	1/2", 3/4", 1", 1 1/2", 2", 2 1/2", 3", 4"
<b>Material:</b>	Passivated 316 Stainless Steel (ASTM A351, CF8M)
<b>Connections:</b>	Clamp & weld - other connections available upon request
<b>Working Pressure:</b>	1/2" - 1"            1,000 psi 1 1/2" - 2"        1,000 psi 2 1/2" - 4"        800 psi
<b>Temperature Rating:</b>	-65 to 350 Degrees F

## ORDERING SPECIFICATIONS...

<b>Specify:</b>	<ul style="list-style-type: none"><li>• Quantity</li><li>• Product description or Part No.</li><li>• Size</li></ul>
-----------------	---

## IMPORTANT FEATURES...

- Meets 3A requirements
- 100% Tested
- Valves marked with heat numbers for full identification and traceability
- English hardware
- Reinforced Teflon® Seats
- PTFE Cavity Filler, fully encapsulated
- Locking device handle
- Air Actuator ISO-5211 mounting pad standard on all valves
- Repair kits are available
- L Port is standard. T Port available upon request

# 3 - WAY BALL VALVES

## EG93CCC - CLAMP

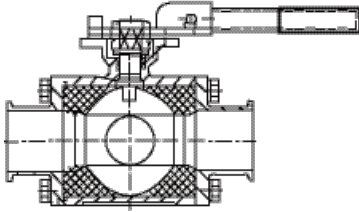

Size Tube OD	L - PORT	T - PORT
1/2	\$344.45	\$344.45
3/4	\$411.12	\$411.12
1	\$544.45	\$544.45
1 1/2	\$911.12	\$911.12
2	\$1,360.00	\$1,360.00
2 1/2	\$2,266.67	\$2,266.67
3	\$3,111.12	\$3,111.12
4	\$4,133.33	\$4,133.33

## E93WWW - WELD

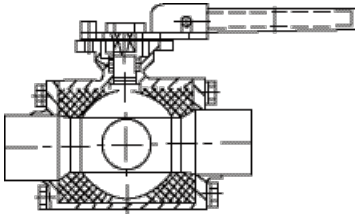

Size Tube OD	L - PORT	T - PORT
1/2	\$344.45	\$344.45
3/4	\$411.12	\$411.12
1	\$544.45	\$544.45
1 1/2	\$911.12	\$911.12
2	\$1,360.00	\$1,360.00
2 1/2	\$2,266.67	\$2,266.67
3	\$3,111.12	\$3,111.12
4	POA	POA

## REPLACEMENT PARTS

	Part Number	List Price
Handle	Ball - 3 - 14 - .5	\$44.45
	Ball - 3 - 14 - .75	\$44.45
	Ball - 3 - 14 - 1.0	\$44.45
	Ball - 3 - 14 - 1.5	\$55.56
	Ball - 3 - 14 - 2.0	\$55.56
	Ball - 3 - 14 - 2.5	\$55.56
	Ball - 3 - 14 - 3.0	\$66.67
	Ball - 3 - 14 - 4.0	POA
Repair Kit	Ball - 3 - Kit - .5	\$60.00
	Ball - 3 - Kit - .75	\$66.67
	Ball - 3 - Kit - 1.0	\$111.12
	Ball - 3 - Kit - 1.5	\$200.00
	Ball - 3 - Kit - 2.0	\$333.34
	Ball - 3 - Kit - 2.5	\$666.67
	Ball - 3 - Kit - 3.0	\$1,188.89
	Ball - 3 - Kit - 4.0	\$1,625.00



## Spring Return Pneumatic Actuator



Part Number	List Price
BI-52-SR	\$303.17
BI-63-SR	\$322.77
BI-75-SR	\$446.03
BI-85-SR	\$478.08
BI-100-SR	\$581.98
BI-115-SR	\$825.09
BI-125-SR	\$929.19
BI-140-SR	\$1779.56
BI-160-SR	\$2039.51
BI-200-SR	\$3374.42

## Double Acting Pneumatic Actuator



Part Number	List Price
BI-32-DA	\$176.10
BI-52-DA	\$276.76
BI-63-DA	\$293.49
BI-75-DA	\$410.82
BI-85-DA	\$449.93
BI-100-DA	\$537.98
BI-115-DA	\$768.45
BI-125-DA	\$821.59
BI-140-DA	\$1456.00
BI-160-DA	\$1761.04

## Dome Indicator 110V W/Limit Switches

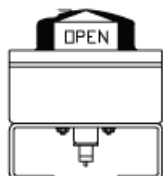

Part Number	List Price
BALL-ACT-110V-DOME	\$503.71

## Solenoid 120V

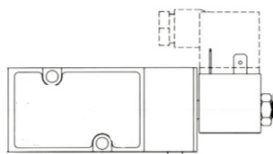

Part Number	List Price
BALL-ACT-120V-4	\$227.17

# VALVES



**PVA Valves**

## PVA VALVE

### VNE'S MODULAR DESIGN SANITARY PROCESS VALVE

#### PVA VALVE....

This valve has an all stainless one piece stem which seals against the body O-ring for positive shut off. With this design, no seals, disks, or O-rings are fastened to the stem, which could cause product entrapment.

#### MODULAR DESIGN....

A modular design is used throughout this entire line of valves.

#### SANITARY....

PVA valves meet 3A requirements. With this state of the art design, it allows optimum CIP cleaning of all product contact surfaces.

#### PVA VALVE....

- Available in 1.5" - 3"
- Made from T316L Stainless Steel
- Offered as EPDM Standard with Viton® and Silicone options.
- Available in Shut off, Divert, and Tank Outlet Configurations.
- Available with Clamp, Weld, Bevel Seat, and E-Line connections. Other connections are available upon request.
- Available in manual or air actuated. An electronic control head can be used with these air operated valves.

#### PVA ACCESSORIES....

- Micro switches with Solenoid Valve 110 or 24 volt.
- Indicating lights for open and closed position.
- Tank Bottom Adapter - For Tank Outlet Valve



#### PVA ACTUATOR....

- Maintenance free
- Instantly reversible from normally open (NO) to normally closed (NC) or vice versa.
- Instant assembly of electronic control head.
- Two size Actuators: 4" diameter for 1 1/2" and 2" valves. 5" size for 2 1/2" and 3" valves. Made from T304 Stainless Steel.
- Position indicator stem on top of actuator shows open or closed position.
- Operating Air Pressure range 72 - 108 PSI.



#### VNE CORPORATION

P.O. Box 1698 • 1149 Barberry Drive • Janesville, WI 53547

TEL: 608-756-4930 • FAX: 608-756-3643 • 1-800-356-1111 • Web site: vnestainless.com

### EGPVA - SHUT OFF - CLAMP

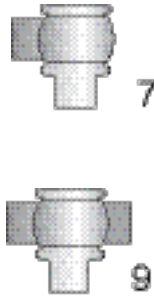
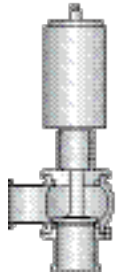

Size	Silicone	EPDM	Viton
1 1/2	\$1,444.45	\$1,444.45	\$1,500.00
2	\$1,555.56	\$1,555.56	\$1,611.12
2 1/2	\$1,722.23	\$1,722.23	\$1,777.78
3	\$1,977.78	\$1,977.78	\$2,033.34
1 1/2	\$1,533.34	\$1,533.34	\$1,588.89
2	\$1,711.12	\$1,711.12	\$1,766.67
2 1/2	\$1,955.56	\$1,955.56	\$2,011.12
3	\$2,222.23	\$2,222.23	\$2,277.78

### EPVA - SHUT OFF - WELD

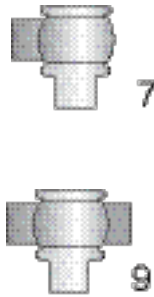
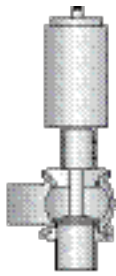

Size	Silicone	EPDM	Viton
1 1/2	\$1,444.45	\$1,444.45	\$1,500.00
2	\$1,555.56	\$1,555.56	\$1,611.12
2 1/2	\$1,722.23	\$1,722.23	\$1,777.78
3	\$1,977.78	\$1,977.78	\$2,033.34
1 1/2	\$1,533.34	\$1,533.34	\$1,588.89
2	\$1,711.12	\$1,711.12	\$1,766.67
2 1/2	\$1,955.56	\$1,955.56	\$2,011.12
3	\$2,222.23	\$2,222.23	\$2,277.78

### EGPVA - TANK BOTTOM - CLAMP

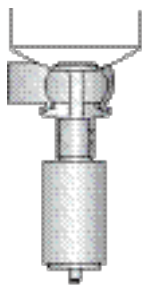

Size	Silicone	EPDM	Viton
1 1/2	\$1,555.56	\$1,555.56	\$1,611.12
2	\$1,666.67	\$1,666.67	\$1,722.23
2 1/2	\$1,833.34	\$1,833.34	\$1,888.89
3	\$2,088.89	\$2,088.89	\$2,200.00

### EPVA - TANK BOTTOM - WELD



Size	Silicone	EPDM	Viton
1 1/2	\$1,555.56	\$1,555.56	\$1,611.12
2	\$1,666.67	\$1,666.67	\$1,722.23
2 1/2	\$1,833.34	\$1,833.34	\$1,888.89
3	\$2,088.89	\$2,088.89	\$2,200.00

### EGPVA - DIVERT - CLAMP

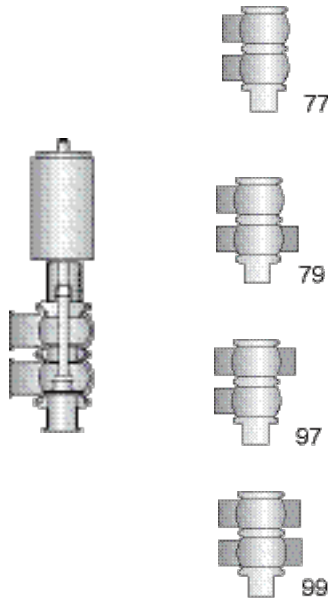

Size	Silicone	EPDM	Viton
1 1/2	\$1,777.78	\$1,777.78	\$2,000.00
2	\$1,955.56	\$1,955.56	\$2,177.78
2 1/2	\$2,244.45	\$2,244.45	\$2,466.67
3	\$2,666.67	\$2,666.67	\$2,888.89
1 1/2	\$1,888.89	\$1,888.89	\$2,111.12
2	\$2,066.67	\$2,066.67	\$2,288.89
2 1/2	\$2,355.56	\$2,355.56	\$2,577.78
3	\$2,777.78	\$2,777.78	\$3,000.00
1 1/2	\$1,888.89	\$1,888.89	\$2,111.12
2	\$2,066.67	\$2,066.67	\$2,288.89
2 1/2	\$2,355.56	\$2,355.56	\$2,577.78
3	\$2,777.78	\$2,777.78	\$3,000.00
1 1/2	\$2,000.00	\$2,000.00	\$2,222.23
2	\$2,177.78	\$2,177.78	\$2,400.00
2 1/2	\$2,466.67	\$2,466.67	\$2,688.89
3	\$2,888.89	\$2,888.89	\$3,111.12

### EPVA - DIVERT - WELD

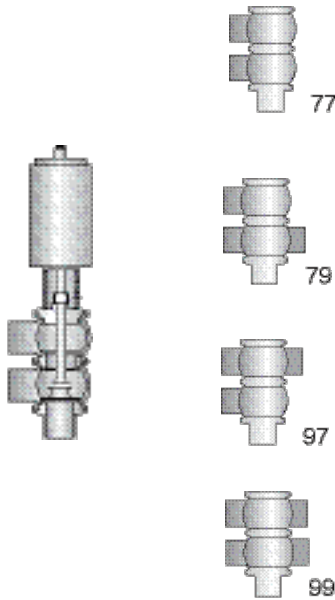

Size	Silicone	EPDM	Viton
1 1/2	\$1,777.78	\$1,777.78	\$2,000.00
2	\$1,955.56	\$1,955.56	\$2,177.78
2 1/2	\$2,244.45	\$2,244.45	\$2,466.67
3	\$2,666.67	\$2,666.67	\$2,888.89
1 1/2	\$1,888.89	\$1,888.89	\$2,111.12
2	\$2,066.67	\$2,066.67	\$2,288.89
2 1/2	\$2,355.56	\$2,355.56	\$2,577.78
3	\$2,777.78	\$2,777.78	\$3,000.00
1 1/2	\$1,888.89	\$1,888.89	\$2,111.12
2	\$2,066.67	\$2,066.67	\$2,288.89
2 1/2	\$2,355.56	\$2,355.56	\$2,577.78
3	\$2,777.78	\$2,777.78	\$3,000.00
1 1/2	\$2,000.00	\$2,000.00	\$2,222.23
2	\$2,177.78	\$2,177.78	\$2,400.00
2 1/2	\$2,466.67	\$2,466.67	\$2,688.89
3	\$2,888.89	\$2,888.89	\$3,111.12

### REPLACEMENT PARTS



Part Number	List Price
PVAP - Manual - All	\$200.00
PVAP - 1 - NC - 1.5 & 2.0	\$722.23
PVAP - 1 - NC - 2.5 & 3.0	\$877.78
PVAP - 1 - NC - 1.5 & 2.0 - 110V(24V)	\$1,533.34
PVAP - 1 - NC - 2.5 & 3.0 - 110V(24V)	\$1,666.67

#### STEM - SHUT OFF

Size	Part Number	List Price
1 1/2	PVAP - 7 - 13 - 1.5	\$100.00
2	PVAP - 7 - 13 - 2.0	\$122.23
2 1/2	PVAP - 7 - 13 - 2.5	\$133.34
3	PVAP - 7 - 13 - 3.0	\$150.00

#### STEM - DIVERT

1 1/2	PVAP - 77 - 13 - 1.5	\$155.36
2	PVAP - 77 - 13 - 2.0	\$195.56
2 1/2	PVAP - 77 - 13 - 2.5	\$233.34
3	PVAP - 77 - 13 - 3.0	\$273.34

#### STEM - TANK BOTTOM

1 1/2	PVAP - TANK - 4 - 1.5	\$100.00
2	PVAP - TANK - 4 - 2.0	\$122.23
2 1/2	PVAP - TANK - 4 - 2.5	\$133.34
3	PVAP - TANK - 4 - 3.0	\$150.00

#### SEAT SEAL - PVAP - 9

Size	Silicone	EPDM	Viton
1 1/2	\$28.89	\$11.12	\$34.45
2	\$30.00	\$21.34	\$43.89
2 1/2	\$31.12	\$22.23	\$46.67
3	\$35.56	\$26.67	\$53.34

#### STEM O-RING - PVAP - 8

1 1/2	\$17.78	\$4.45	\$23.34
2	\$17.78	\$4.45	\$23.34
2 1/2	\$22.23	\$8.89	\$33.34
3	\$22.23	\$8.89	\$33.34

# COMPRESSION VALVE

STAINLESS STEEL VALVES  
PRODUCT CATALOG

## EG60C-7-R

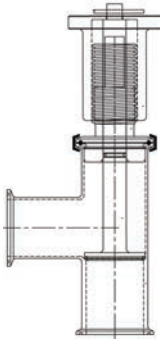

Size	List Price
1	\$1257.78
1 1/2	\$1333.34
2	\$1600.00
2 1/2	Call VNE
3	Call VNE

## REPLACEMENT PARTS

	Part Number	List Price
O-Ring Stem Seal - Viton	EG60C-7-R-1.0-2B	\$1.12
	EG60C-7-R-1.5-2B	\$1.12
	EG60C-7-R-2.0-2B	\$1.12
	EG60C-7-R-2.5-2B	Call VNE
	EG60C-7-R-3.0-2B	Call VNE
O-Ring Stem Seat - Viton	EG60C-7-R-1.0-2C	\$2.23
	EG60C-7-R-1.5-2C	\$2.23
	EG60C-7-R-2.0-2C	\$2.67
	EG60C-7-R-2.5-2C	Call VNE
	EG60C-7-R-3.0-2C	Call VNE